

**ATIZ**

# BookDrive Mini

Pro performance in compact size.



## Atiz Fast Facts

- › The most budget friendly book scanner brand in the world.
- › Over 800 installations around the globe.
- › Responsible for scanning over 3 million books.
- › Atiz scanners are currently being used by some of the most prominent academic libraries, universities and museums around the world.

# What is BookDrive Mini?

BookDrive Mini solves all problems found in book scanners. Problems of conventional scanners are page curvature, damage to book spine and low productivity.















BookDrive uses a different approach called a V-shaped solution. The V-shaped glass and book cradle hold the book open at a non-stressful angle for scanning by hi-speed, hi-resolution digital SLR cameras. This unique design guarantees sharp, curvature-free images in every scan.

This unique design guarantees sharp, curvature-free images in every scan. Our V-shaped solution has helped hundreds of libraries worldwide scan millions of books.



## The Evolution of Scanners

We've come a long way from flatbed and planetary scanners. Thanks to advances in digital cameras, today the v-shaped book scanners from Atiz are-empowering libraries around the world to scan millions of books.

Scanner	 Flatbed scanner	 Planetary scanner	 V-shaped book scanner
Book placement	 Face down on 180° plane	 Face up on 180° plane	 Face up on V cradle
Image capture tech	 Linear sensor captures one line at a time	 1 sensor captures spread pages	 2 sensors individually capture a true left page and a true right page
Book centering	Book must be correctly positioned for every scan	Book binding creeps from left to right as pages are turned resulting in margin crawl	Book binding is centered throughout scanning Further handling not required
Flattener	 Stress on bindings	 Fingers holding the pages from flapping	 V-glass gently engages the pages
Capture method	Manual capture Button at every scan	Manual capture Button or foot pedal every scan	Automatic capture Timer and automatic sensor
Results	 Curved text lines Mess near the binding	 Curved text lines Requires software fix	 Straight text lines Natively curvature-free

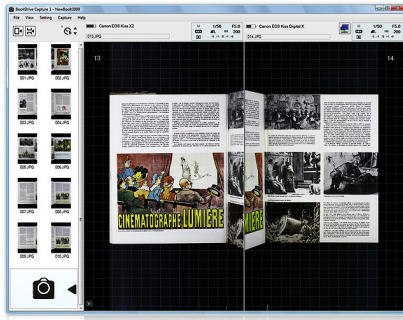

## BookDrive Capture

BookDrive Capture is the application that controls the cameras. It supports a wide range of Canon EOS SLR cameras and allows you to change camera settings from directly within the software.

Press one button and the twin cameras will shoot left and right pages and render them on screen immediately. You will have a true left page and a true right page just like the originals.

### Fast shooting

The cameras capture both left and right pages at the same time. Each shot takes less than a second to photograph. This allows you to capture up to 800 pages an hour.

### In-software camera settings

You can easily change camera settings such as shutter speed, aperture and ISO values within the software.

### Timed Lapse Capture

The timed lapse capture is available so that the cameras can be triggered to shoot automatically at every pre-defined intervals of 1-10 seconds. Users simply flick through the pages.

### RAW support

BookDrive supports the RAW format or the uncompressed, unprocessed pixel information straight from the camera's image sensor. A full RAW workflow lets you capture, post-process and convert RAW files to other lossless formats such as TIFF.

### Easy insert and replace

You can easily insert missing pages which have been skipped or if some shots look bad, you can replace them with new ones. No need to worry about file names because the software will name the inserted files and rename all the effected files correctly.

### Metadata

The metadata of the books such as title, author's name and year published can be recorded in a standard compliant XML file for future use in search and record keeping.



## BookDrive Editor Pro

BookDrive Editor Pro is for post-scan image processing. It's all you need to convert scanned images into final output of the highest quality, ready for distribution or archiving.

The robust image enhancement tools and the intuitive user interface come together to deliver professional results with minimal fuss.

### Fast Batch Processing

For unattended, hassle-free operation, scan the entire book and select the desired settings for the first pair, then BookDrive Editor will automatically apply those settings to the remaining images.

### Book Profiling

To help users get started quickly, the software comes with recommended profiles for frequently used kinds of books, such as textbook and magazines. Users can also create and save custom profiles for later use with similar kind of books.

### Adaptive Local Thresholding for B&W Conversion

An advanced algorithm intelligently converts each pixel to black or white according to its blackness level relative to the surrounding area to help retain greater details compared to standard techniques.

### Multi-book, multi-chapter operation

You can load many chapters or books, set different parameters for each chapter and process all of them in one operation to save time.

### Background Removal

Replaces an unwanted tinted page background common in old books with a bright and clear background free from speckles and stains.

### And a lot more...

Other features include rotation, de-skew, crop, auto level, brightness and contrast adjustment, sharpen, black border removal, image resize and DPI adjustment, etc. Available output formats include PDF (single-page or multi-page files), TIFF (LZW and CCITT Group 4, single-page or multi-page file), and JPEG.

### Software Requirements

- Windows 7, Windows Vista, Windows XP with Service Pack 3 or later
- Single PC (sequential shooting) mode requires 1 PC
- Dual PC (simultaneous shooting) mode requires 2 PCs

- CPU 1GHz or higher
- RAM 2GB minimum
- 10GB available disk space
- 1024 x 768 resolution monitor

## Compatible cameras and lenses for BookDrive Mini

### Cameras with 1.6x field of view crop

- Canon EOS 350D (XT)
- Canon EOS 1000D (XS)
- Canon EOS 400D (XTi)
- Canon EOS 450D (XSi)
- Canon EOS 20D
- Canon EOS 30D
- Canon EOS 40D

+



Zoom lens EF-s18-55MM

### Full frame cameras

- Canon EOS 5D Mark II

+



EF 50MM f1.8/II

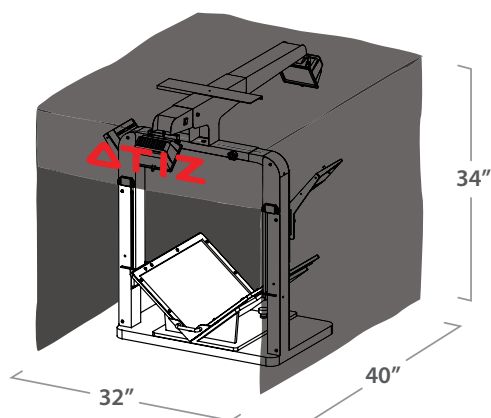

Height: 34 inches (86 cm)  
 Width: 32 inches (82 cm)  
 Depth: 40 inches (102 cm)  
 Weight: 57 lbs (26 kg)



Maximum scanning area: 10 x 15 inches (25.5 x 38 cm)  
 Maximum book thickness: 5 cm

### Base

- The platform
- Adjustable camera mount x 2
- V-shaped book cradle
- V-shaped transparent platen
- LED lighting panels
- Glare-prevention shade
- USB hub
- Software Installation CD
- - 1 license of BookDrive Capture software
- - 1 license of BookDrive Editor Pro software
- Printed and electronic documentation

### Optional

- Digital SLR cameras x 2
- Recommended lenses x 2
- AC Adapters x 2

The information on this brochure is subject to change without notice. Please visit [www.atiz.com](http://www.atiz.com) for the most current information.

**Headquarter** Atiz Innovation Co., Ltd. 729/26 - 27, Ratchadaphisek Rd., Bangpongpan, Yannawa, Bangkok 10120, Thailand  
 P: +66.2683.6600 +66.2683.6070 - 1 F: +66.2683.6072 E: [info@atiz.com](mailto:info@atiz.com)

**UK** Allied Images Ltd, 53 Tenter Road, Moulton Park, Northampton, UK. NN3 6AX  
 P: +44.(0)1604.670679 F: +44.(0)1604.670876 E: [sales@allied-images.com](mailto:sales@allied-images.com)